

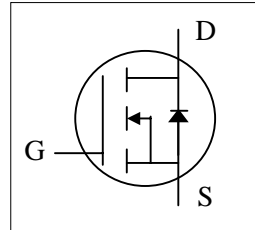

- ▼ Low On-resistance
- ▼ Simple Drive Requirement
- ▼ Fast Switching Characteristic



BV_{DSS}	500V
$R_{DS(ON)}$	0.43 Ω
I_D	16A

Description

Advanced Power MOSFETs from APEC provide the designer with the best combination of fast switching, ruggedized device design, low on-resistance and cost-effectiveness.

The TO-220CFM isolation package is widely preferred for commercial-industrial through hole applications.

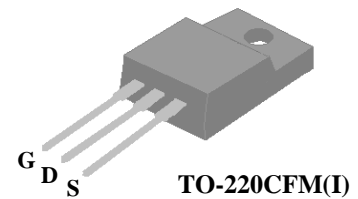

Absolute Maximum Ratings

Symbol	Parameter	Rating	Units
V_{DS}	Drain-Source Voltage	500	V
V_{GS}	Gate-Source Voltage	± 30	V
$I_D @ T_C = 25^\circ C$	Continuous Drain Current, $V_{GS} @ 10V$	16	A
$I_D @ T_C = 100^\circ C$	Continuous Drain Current, $V_{GS} @ 10V$	11	A
I_{DM}	Pulsed Drain Current ¹	60	A
$P_D @ T_C = 25^\circ C$	Total Power Dissipation	40	W
	Linear Derating Factor	0.31	W/ $^\circ C$
E_{AS}	Single Pulse Avalanche Energy ²	159	mJ
I_{AR}	Avalanche Current	16	A
T_{STG}	Storage Temperature Range	-55 to 150	$^\circ C$
T_J	Operating Junction Temperature Range	-55 to 150	$^\circ C$

Thermal Data

Symbol	Parameter	Value	Units
Rthj-c	Maximum Thermal Resistance, Junction-case	2.5	$^\circ C/W$
Rthj-a	Maximum Thermal Resistance, Junction-ambient	65	$^\circ C/W$



AP4085I

Electrical Characteristics @T_j=25°C(unless otherwise specified)

Symbol	Parameter	Test Conditions	Min.	Typ.	Max.	Units
BV _{DSS}	Drain-Source Breakdown Voltage	V _{GS} =0V, I _D =1mA	500	-	-	V
R _{DS(ON)}	Static Drain-Source On-Resistance ³	V _{GS} =10V, I _D =8A	-	-	0.43	Ω
V _{GS(th)}	Gate Threshold Voltage	V _{DS} =V _{GS} , I _D =250uA	3	-	5	V
g _{fs}	Forward Transconductance	V _{DS} =10V, I _D =8A	-	6.3	-	S
I _{DSS}	Drain-Source Leakage Current	V _{DS} =400V, V _{GS} =0V	-	-	100	uA
I _{GSS}	Gate-Source Leakage	V _{GS} =±30V	-	-	±100	nA
Q _g	Total Gate Charge ³	I _D =16A	-	48	77	nC
Q _{gs}	Gate-Source Charge	V _{DS} =200V	-	9	-	nC
Q _{gd}	Gate-Drain ("Miller") Charge	V _{GS} =10V	-	32	-	nC
t _{d(on)}	Turn-on Delay Time ³	V _{DD} =200V	-	48	-	ns
t _r	Rise Time	I _D =8A	-	134	-	ns
t _{d(off)}	Turn-off Delay Time	R _G =50Ω, V _{GS} =10V	-	195	-	ns
t _f	Fall Time	R _D =25Ω	-	121	-	ns
C _{iss}	Input Capacitance	V _{GS} =0V	-	1205	1930	pF
C _{oss}	Output Capacitance	V _{DS} =30V	-	255	-	pF
C _{rss}	Reverse Transfer Capacitance	f=1.0MHz	-	50	-	pF

Source-Drain Diode

Symbol	Parameter	Test Conditions	Min.	Typ.	Max.	Units
V _{SD}	Forward On Voltage ³	I _S =16A, V _{GS} =0V	-	-	1.3	V
t _{rr}	Reverse Recovery Time	I _S =16A, V _{GS} =0V	-	630	-	ns
Q _{rr}	Reverse Recovery Charge	di/dt=100A/μs	-	13	-	uC

Notes:

- 1.Pulse width limited by Max junction temperature.
- 2.Starting T_j=25°C , V_{DD}=99V , L=1mH , R_G=25Ω
- 3.Pulse test

THIS PRODUCT IS AN ELECTROSTATIC SENSITIVE, PLEASE HANDLE WITH CAUTION.

THIS PRODUCT HAS BEEN QUALIFIED FOR CONSUMER MARKET. APPLICATIONS OR USES AS CRITERIAL COMPONENT IN LIFE SUPPORT DEVICE OR SYSTEM ARE NOT AUTHORIZED.

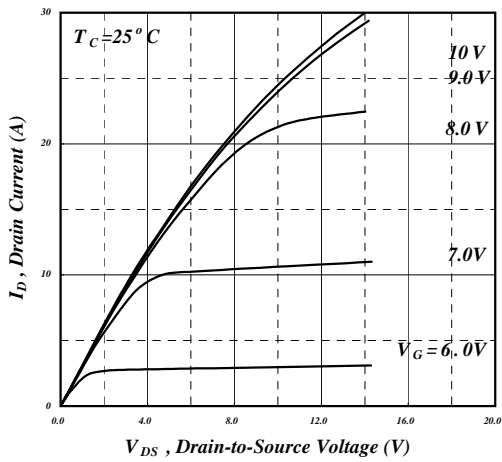

Fig 1. Typical Output Characteristics

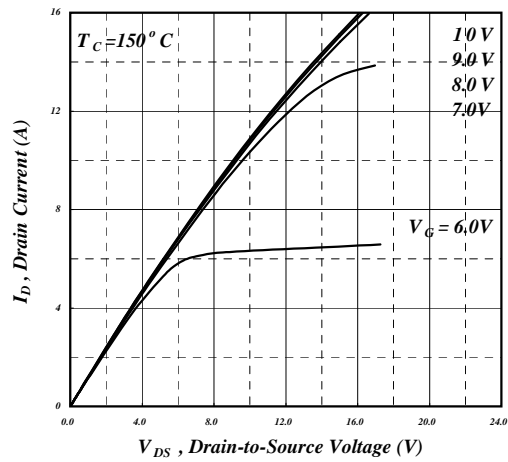

Fig 2. Typical Output Characteristics

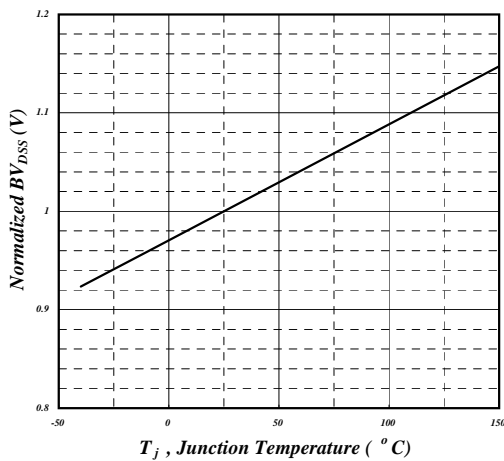

Fig 3. Normalized BV_{DSS} v.s. Junction Temperature

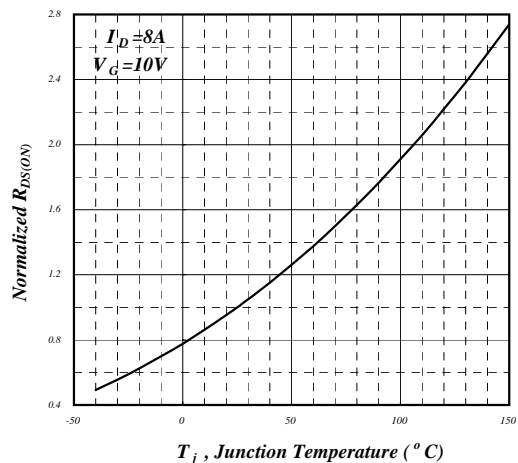

Fig 4. Normalized On-Resistance v.s. Junction Temperature

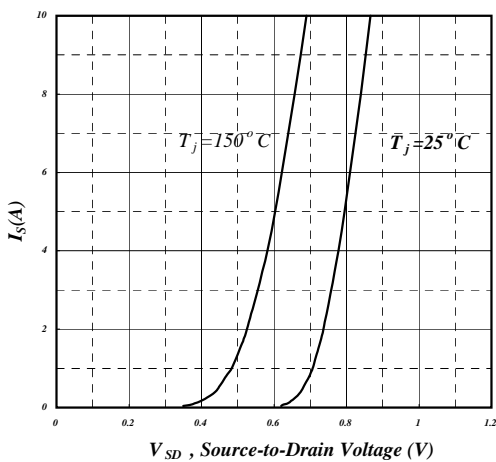

Fig 5. Forward Characteristic of Reverse Diode

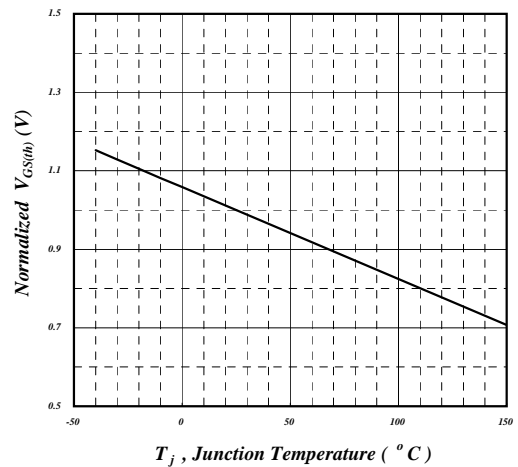

Fig 6. Gate Threshold Voltage v.s. Junction Temperature

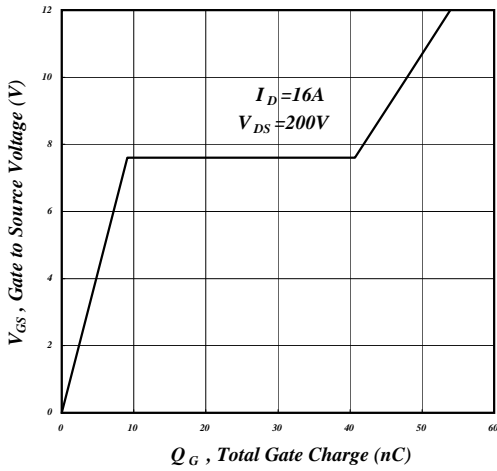

Fig 7. Gate Charge Characteristics

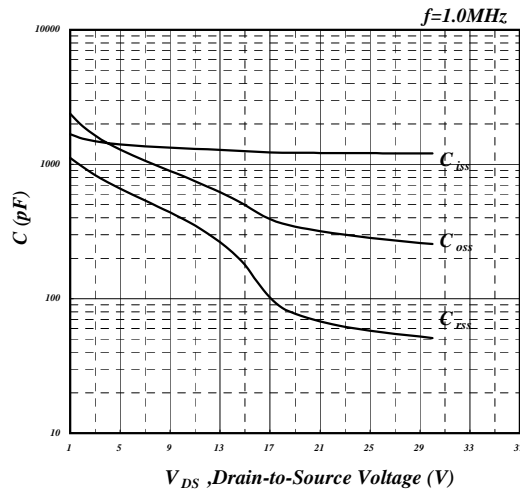

Fig 8. Typical Capacitance Characteristics

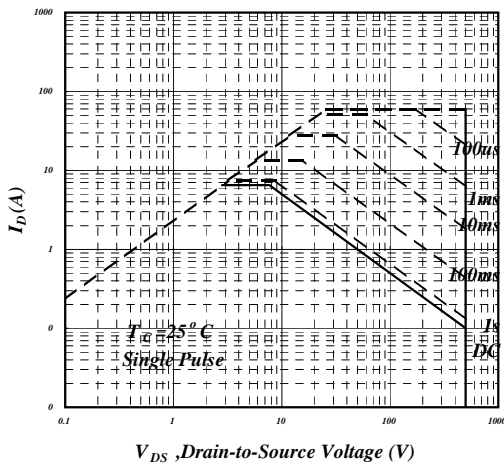

Fig 9. Maximum Safe Operating Area

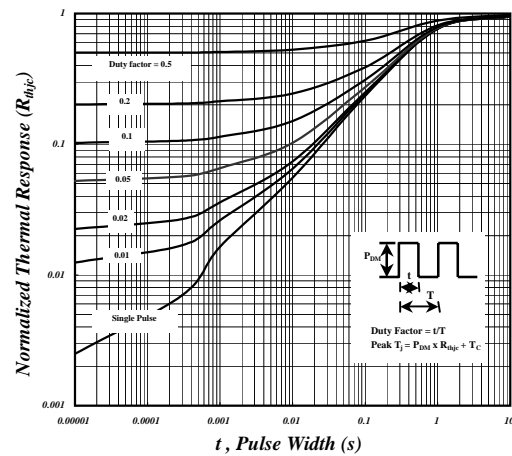

Fig 10. Effective Transient Thermal Impedance

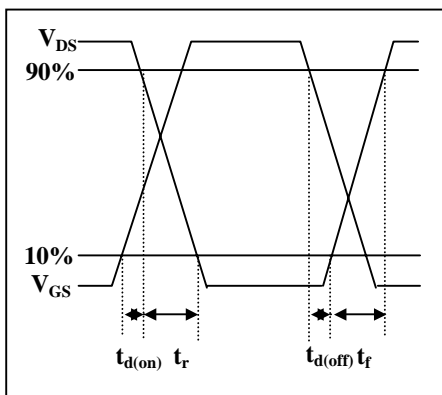

Fig 11. Switching Time Waveform

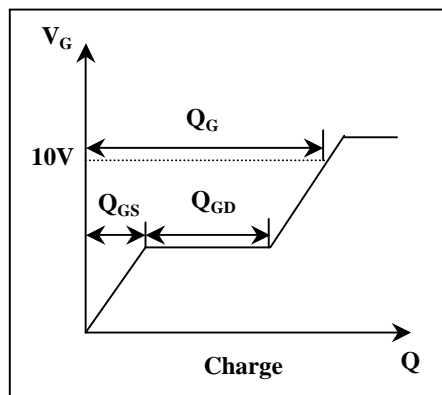
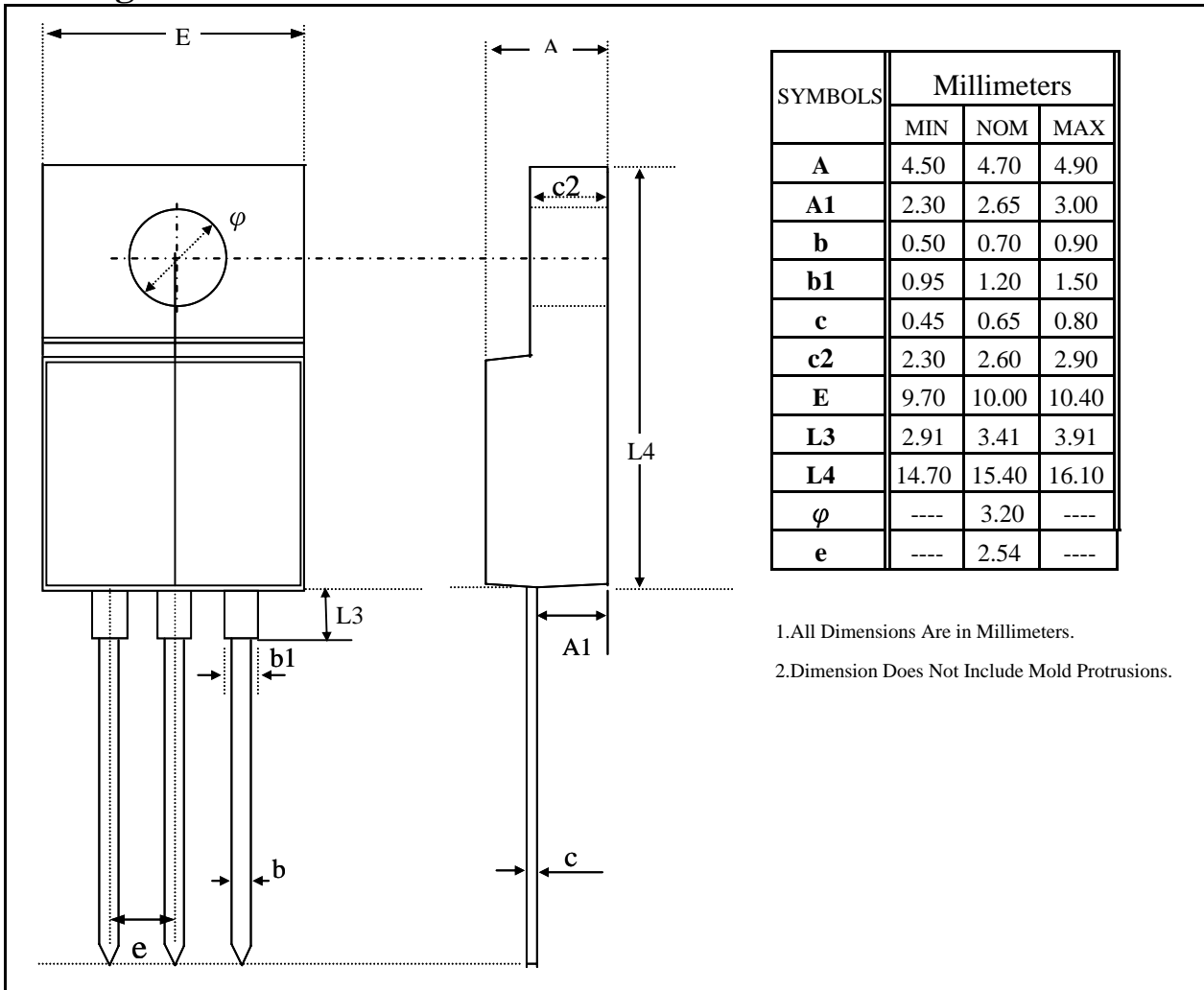

Fig 12. Gate Charge Waveform



Package Outline : TO-220CFM



Part Marking Information & Packing : TO-220CFM

